

# Electrode Steam Homeowner's Manual

HOMEOWNER'S OPERATING MANUAL





# Electrode Steam

## INTRODUCTION

Safety Definitions and Precautions . . . . .	2
Welcome . . . . .	3
How is the Electrode Steam different from other humidifiers? . . . . .	3
What safety features does the Electrode Steam have? . . . . .	3
How should I get started? . . . . .	3
How does the Electrode Steam work? . . . . .	4

## YOUR NEW Electrode Steam

Which Electrode Steam model do I have? . . . . .	5
Which humidity control do I have? . . . . .	6
How is my Electrode Steam installed? . . . . .	6
Remote mounting . . . . .	6
What Electrode Steam parts do I need to know? . . .	7
What should I expect from my Electrode Steam? . . .	8

## EVERYDAY OPERATION

How do I operate the Electrode Steam? . . . . .	9
How do I use the humidity control? . . . . .	9
What should my humidity setpoint be? . . . . .	10
What is a frost setting? . . . . .	10
What do the lights tell me? . . . . .	11

## CLEANING AND MAINTENANCE

What should I do at the end of the season? . . . . .	12
What if I go on vacation? . . . . .	12
What should I do if the LED light is blinking, or if something is wrong? . . . . .	12

## WARRANTY

5-Year Limited Warranty . . . . .	13
-----------------------------------	----

INTRODUCTION

YOUR NEW  
Electrode Steam

EVERYDAY  
OPERATION

CLEANING AND  
MAINTENANCE

WARRANTY



**NEED HELP?** For assistance with this product please visit <http://yourhome.honeywell.com> or call Honeywell Customer Care toll-free at 1-800-468-1502.

**Read and save these instructions.**

# Safety Definitions and Precautions

## Must be installed by a trained, experienced technician.

Read these instructions carefully. Failure to follow these instructions can damage the product or cause a hazardous condition.

Please read this manual completely. It is important that you understand how the Electrode Steam works, and how to safely perform the required maintenance procedures. Read and understand all safety-related labels found on and posted near the Electrode Steam. These labels provide additional instructions and important safety information.

### Safety Definitions

These safety terms identify information you must read.

 **CAUTION:** Indicates a hazardous situation which, if not avoided, could cause bodily injury or property damage.

 **WARNING:** Indicates a hazardous situation which, if not avoided, could result in death or serious injury.

### Safety Precautions

**Make sure you read and understand the following safety hazards before installing, using, or working with the Electrode Steam:**

- Do not direct the steam nozzle at people.
- Water inside cylinder can be very hot. Read the warning label on the Electrode Steam and make sure you understand the hazards of scalding hot water in the cylinder.
- Scalding danger from draining water. When the water tank empties, draining water can be hot enough to cause injury. Make sure you know where the water exits the drain hose. Be certain hot water will not pose a hazard to people or pets.

 **WARNING:** Electrocutation Hazard.

The Electrode Steam uses 120V or 240V, which can cause death or serious injury. Take precautions when service is being performed on the Electrode Steam or when removing the water tank or cover. If in doubt, turn off the breaker which is operating the Electrode Steam and disconnect HVAC equipment power before servicing.

 **CAUTION:** Heavy Equipment and Water Hazard.

Improper installation or misuse can cause death, blindness, and water damage to home. Be sure you know how to turn the Electrode Steam off, and how to drain the water tank safely.

 **CAUTION:** Steam Condensation and Freezing Water Hazard.

Be sure the Electrode Steam Humidifier is located in a conditioned space, as well as having proper condensate and drain line locations. Improper installation can result in water damage to home.

# Welcome!

## Congratulations on your new humidifier.

The Honeywell Electrode Steam humidifier provides the high performance and efficiency of steam, with easier maintenance than traditional humidifiers.

We are sure the Electrode Steam will be a welcome addition to your home.

- **How is the Electrode Steam different from other humidifiers?**

- The steam goes directly into your hot air supply duct, rather than evaporating from a wet pad, which requires furnace temperature to produce humidity efficiently.
- The Electrode Steam delivers humidity independent of your furnace. This allows you to achieve ideal humidity levels in your home, year-round.
- The Electrode Steam wastes less water than flow-through humidifiers.
- The Electrode Steam operates automatically, just like a thermostat, to keep your home's humidity at the desired level.
- The Electrode Steam is easy to maintain. Just have your HVAC professional change the steam cylinder when the unit determines its life is about to expire.

- **What safety features does the Electrode Steam have?**

- Separate sensors and water monitoring (via the electrodes and software) monitor water within the tank. These two important components prevent the tank from being over-filled, running dry, and optimize steam production with various water qualities.
- The auto-adaptive feature monitors the Electrode Steam humidifier's water supply, current, and load. The unit also self-tests on a regular basis, letting you know when the unit should be serviced.

- **How should I get started?** Your Electrode Steam must be installed by an HVAC Professional Installer. If the Electrode Steam has just been installed, it should either be running and humidifying your home, or waiting for a humidity call from the humidity control provided.

Once the Electrode Steam is up and running, all you have to do is use the humidity control to change the humidity to your desired comfort.

- Please read this manual completely for tips on getting the most out of your Electrode Steam.
- Read your humidity control manual and make sure you know how to operate your system.
- If you have questions, now or later, please ask your Installer or call Honeywell Customer Care at 1-800-468-1502.

# How does the Electrode Steam work?

## Steam Generation

- Once the unit receives a demand signal and the safety loop between terminal 1 and 2 is closed, the humidifier closes the contactor and measures the electrical current.
- If the demand is lower than the actual output the inlet valve is kept closed and output is reduced by letting the water level in the cylinder decrease by evaporation.
- If demand is higher than the actual output, after a brief delay the fill valve is activated and water flows into the fill cup. Water from the fill cup flows into the bottom of the cylinder through a hose connected to the drain valve housing.

**Note:** The cylinder is gravity fed from the fill cup. If backpressure from the steam line is too high it will cause water to back up in the fill cup and flow down the overflow line to the drain.

- As soon as the water in the cylinder comes in contact with the energized electrodes, current flows through the water. The resistance of the water to the electrical charge generates heat and in turn steam. The electrical current (and steam output) increases as the level of water increases, as more of the electrode becomes submerged. The unit continues to fill until the current matches demand or the high water sensor detects a high water level.
- The Electrode Steam repeats the fill and boil down cycle repeatedly to match output to demand.
- Over time minerals in the water will adhere to the cylinder electrodes. The humidifier will automatically fill to a higher water level to maintain full capacity during the life of the cylinder. Eventually because of scale formation it will no longer be possible for the humidifier to reach its full capacity. The Electrode Steam software monitors this condition and, when detected, will stop operating and flash the yellow LED in a repeating sequence of 4 flashes.

## Drains

- As steam is produced, minerals are left behind, increasing the conductivity of the water. The Electrode Steam patented auto adaptive cycle will monitor the water conductivity and perform drains to maintain the water at optimal conductivity for peak performance.
- The auto adaptive cycle ensures cylinder life is maximized. It does this by keeping the tightest control and most efficient use of water during the entire cylinder life.

## Steam Distribution

Steam generated by the humidifier may be introduced into the air in several different ways. The most common method for adding the steam into the air is to mount a steam distributor tube in a supply air duct.

## Steam Line

The steam line between the cylinder steam outlet and the distributor serves two purposes: it is used as a conduit to transfer the atmospheric steam from the humidifier to the distributor, as well as providing a means to remove condensate.

## Condensate Return

Whenever steam is distributed condensate is formed in the distribution system. Insulating steam lines is one important way to reduce the amount of condensate formed. Steam lines are sloped so that condensate does not collect in the lines and create a restriction to steam flow. The condensate must be collected and removed from the system so that it does not build up and leak into the duct. Condensate can be returned to the Electrode Steam fill cup to reduce water waste or can be fed to drain.

# Which Electrode Steam model do I have?

The Electrode Steam is available in two sizes, each with a different humidifying capacity:

The Electrode Steam produces 11 gallons per day (GPD) when run on 120 V and 22 GPD when run on 240 V. It is generally suitable for homes 8,000 to 32,000 cubic feet in size.

The proper model for your home depends on many factors. Size of the area to be humidified, ceiling height, window and insulation type, as well as your geographic area, all affect how much humidity your home needs.

Some activities in your home may create heavier loads for the Electrode Steam. Vented fireplaces, high exhaust from fans, or driers can reduce humidity in your home and make the Electrode Steam work harder.

Your Professional Installer or salesperson will have considered these and other factors when choosing the best Electrode Steam model for your unique situation.

This label displays the model number and date code of your Electrode Steam.

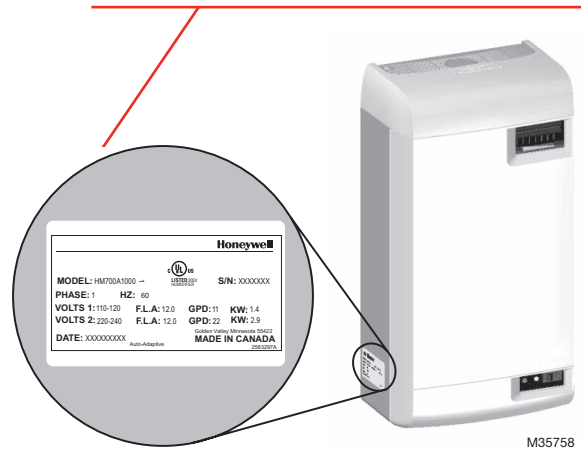

**YOUR NEW  
Electrode Steam**

## Sizing

**IMPORTANT:** The Electrode Steam should only be installed if it has been sized properly. Do not use square feet when sizing a humidifier installation. Instead, cubic feet must be used, since the humidity is filling a volume of space (width x length x height). Also, take into consideration the “tightness” of a home’s construction.

**Table 1. AHRI Recommended Humidity (in gallons per day).**

Construction Type	8,000 ft <sup>3</sup>	12,000 ft <sup>3</sup>	16,000 ft <sup>3</sup>	20,000 ft <sup>3</sup>	24,000 ft <sup>3</sup>	28,000 ft <sup>3</sup>	32,000 ft <sup>3</sup>
Tight	3.3	4.3	5.4	7.5	9.6	11.7	16
Average	7.6	9.6	11.8	16	20.3	24.4	33
Loose	11.7	14.9	18.1	24.5	30.8	37.1	50

**Table 2. Steam humidifier(s) necessary for application.<sup>a</sup>**

Construction Type	8,000 ft <sup>3</sup>	12,000 ft <sup>3</sup>	16,000 ft <sup>3</sup>	20,000 ft <sup>3</sup>	24,000 ft <sup>3</sup>	28,000 ft <sup>3</sup>	32,000 ft <sup>3</sup>
Tight	11 GPD	11 GPD	11 GPD	11 GPD	11 GPD	11 GPD (x2) or 22 GPD (x1)	11 GPD (x2) or 22 GPD (x1)
Average	11 GPD	11 GPD	22 GPD	22 GPD	22 GPD	11 GPD (x3) or 22 GPD (x2)	11 GPD (x3) or 22 GPD (x2)
Loose	22 GPD	22 GPD	22 GPD	11 GPD (x3) or 22 GPD (x2)	11 GPD (x3) or 22 GPD (x2)	11 GPD (x4) or 22 GPD (x2)	11 GPD (x5) or 22 GPD (x3)

<sup>a</sup> In the table above, 11 GPD indicates a steam humidifier configured to run on 120 V and 22 GPD indicates a steam humidifier configured to run on 240 V.

## Which humidity control do I have?

The Electrode Steam comes supplied with a HumidiPRO Digital Control (see below), or you can use your home thermostat (Prestige IAQ, VisionPro, or Lyric). You will use the humidity control to set the desired humidity level for your home, and to turn the Electrode Steam on and off.



### HumidiPRO Digital Control

- Automatic humidification control with advanced window protection
- Optional manual humidification or dehumidification control

YOUR NEW  
Electrode Steam

## How is my Electrode Steam installed?

Your HVAC Professional Installer will install the Electrode Steam in a proper location in your home. The best location depends on your furnace type and configuration, and how your living space is arranged around the furnace ducts. Your Electrode Steam will be remote mounted.

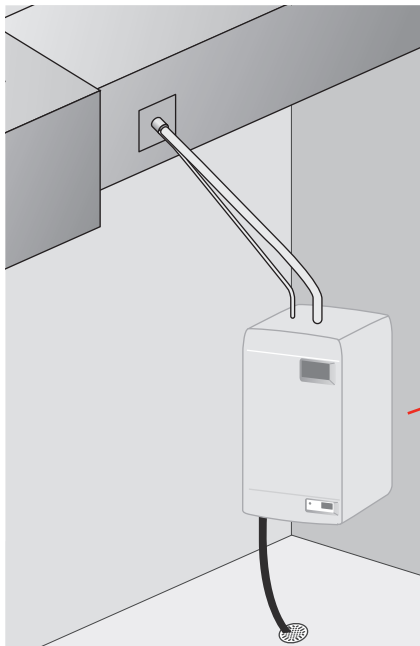

**Remote mounting.** The Electrode Steam is installed some distance away from your furnace supply duct. An insulated hose carries steam from the Electrode Steam to a suitable location on the supply duct.

Remote mounting is required for the Electrode Humidifier.



# What Electrode Steam parts do I need to know?

You should be familiar with the following components:

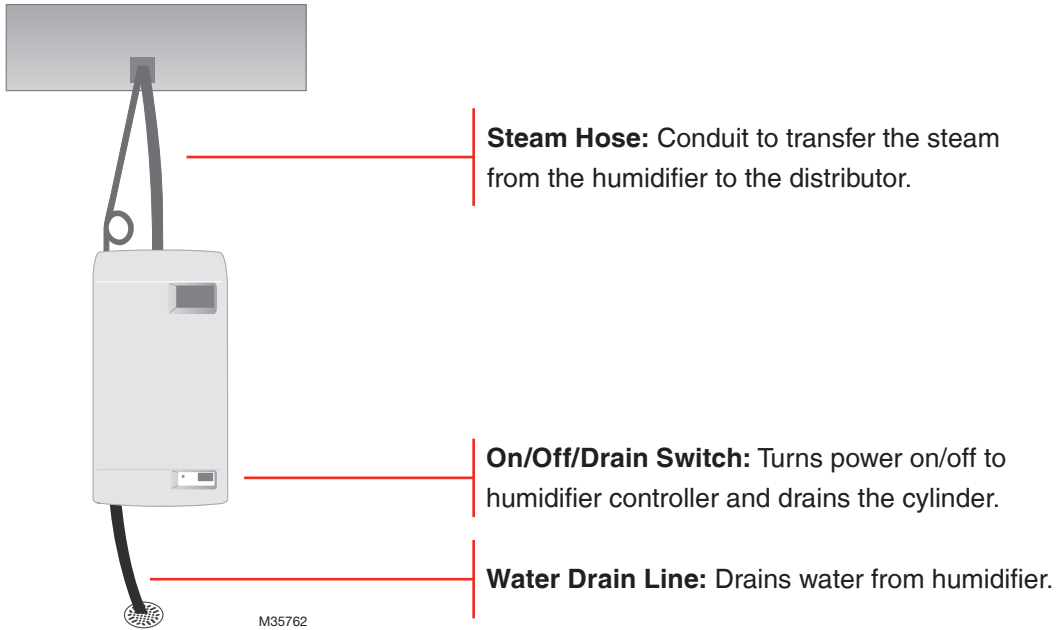

**HumidiPRO Digital Control:** Controls humidity levels, and turns on/off the Electrode Steam.



**Cylinder:** Current heats the water inside the cylinder to make steam.

YOUR NEW  
Electrode Steam

# What should I expect from my Electrode Steam?

Honeywell wants to make sure you know what to expect from your new Electrode Steam installation. Make sure you discuss these items with your Professional Installer:

- **Achieving Humidity Setpoint.** It may take up to a week of continuous operation to initially achieve the humidity setpoint. This depends on factors such as weather, size of home, furnishings in the home, and insulation. Once this is achieved, the Electrode Steam should not have to run as much to maintain humidity.
- **On/Off Noise.** When the humidifier starts up after being off, the unit will run a self-test sequence and may a “click” noise, engaging the fill & drain valves. This is normal .
- **Ideal Humidity.** 35% relative humidity in typical winter weather is considered ideal for indoor comfort by industry experts. You can adjust to your own comfort or until there is condensation on the windows. Lower the setpoint if condensation appears.
- **Unit Not Humidifying.** If the Electrode Steam is not running but the humidity is below the desired setting, the humidity control may have a frost protection setting. See “What is a frost setting?” on page 10. The Cylinder may also be at the end of its life, in which case you will be notified by the LED sequence.
- **Setpoint Not Reached.** If humidity doesn’t reach the setpoint, the Electrode Steam may be under-sized for the home. This can be due to insulation, windows, arid climate, and other environmental factors. Also, the outdoor temperature may be too low to maintain the humidity level.
- **Home Ventilation.** Excessive ventilation exhausts humidified air and replaces it with dry air. This can make it hard to maintain the humidity setpoint. If you are installing a ventilator, use a solution that retains moisture. An Energy Recovery Ventilator (ERV) is recommended.
- **LED Status Lights.** The HM700 user interface includes 2 LEDs that provide information about the humidifier status. Please see “What do the lights tell me?” on page 11 for more information.
- **Water Draining.** It is normal for the Electrode Steam to periodically drain some water automatically. This is due to the humidifier maintaining the perfect level of water conductivity and steam output.
- **Water Conductivity.** Your home’s water conductivity determines how quickly the Electrode Steam will produce steam and also how often the replacement steam cylinder needs to be replaced.
- **Energy Consumption.** You may notice a slight increase in overall energy consumption when operating any humidifier. However, the Electrode Steam will make the home feel warmer. This allows you to lower the temperature setting on the thermostat. Every degree lower on the thermostat can save up to 3% on heating costs.

# How do I operate the Electrode Steam?

Once the Electrode Steam is installed and running, operation is automatic. Use the humidity control provided to make any changes to the setpoint, or to turn the Electrode Steam on or off.

Your Professional Installer configured the Electrode Steam so that it only creates steam when conditions in your HVAC system are right. Steam can only be produced when your system fan is blowing air through the duct.

Ask your Professional Installer if you have questions about how to operate the Electrode Steam.

- **How do I use the humidity control?** Whenever humidity in the home is lower than the humidity control's setpoint, the control will call for humidity. Some controls will also monitor outdoor conditions to ensure indoor humidity does not condense on windows and walls. Refer to the manual provided with your humidity control for instructions on setting the control. There are two different types of humidity control:

**Thermostat with integrated humidity control (such as Prestige IAQ, VisionPRO 8000, or Lyric).**

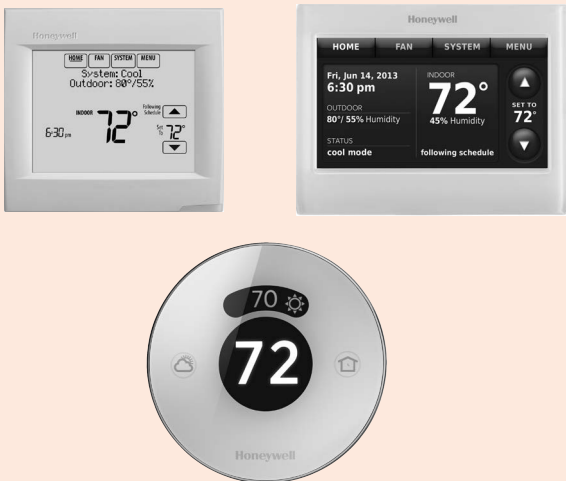

This arrangement allows you to control your furnace, central air conditioning, and Electrode Steam, all with one device.

**Humidity control separate from the thermostat (such as the HumidiPRO).**

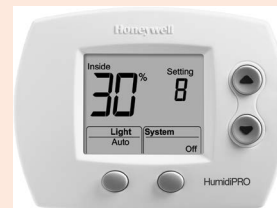

With this arrangement, you will use your current thermostat to control your furnace and central air conditioning. Use the separate humidity control to control your Electrode Steam.

EVERYDAY  
OPERATION

- **What should my humidity setpoint be?** The outdoor air temperature affects how much humidity can be retained by the air in your home. Use this table as a starting point. Then adjust the humidity control to your own comfort or until condensation appears on the windows.

Outdoor Temperature	Recommended Relative Humidity Setting
-20°F (-29°C)	15%
-10°F (-23°C)	20%
0°F (-18°C)	25%
10°F (-12°C)	30%
20°F (-7°C)	35%
>20°F (-1°C)	35%

EVERYDAY OPERATION

- **What is a frost setting?** Some humidity controls (such as Prestige, VisionPRO 8000, and HumidiPRO) contain a Window Frost Protection feature which limits humidity output based on outdoor conditions. For example, on colder days, the air in your home can hold less humidity. The humidity control automatically lowers the humidity setpoint accordingly, to prevent frost from appearing on the inside of your windows.

Lower the frost setting by one value each morning that you see frost or condensation on windows. Allow 24 hours for the new setting to take effect before re-adjusting. Once you have this set to a comfortable level without condensation, you will not need to adjust further. You can adjust your humidity setpoint without worrying about condensation.

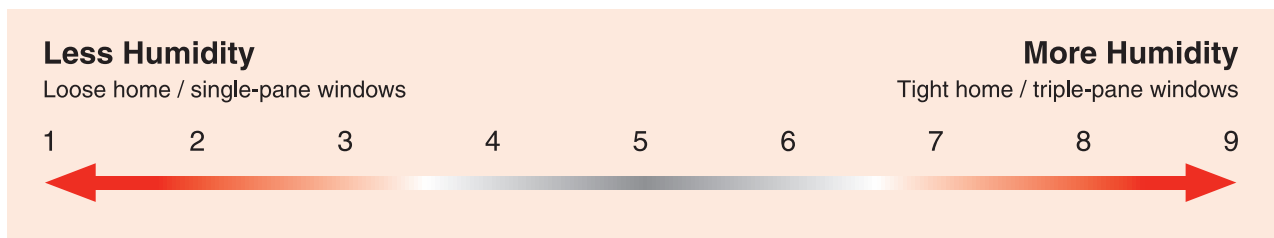

MCR27982

Manual humidity controls do not have built-in frost settings. They require you to adjust the humidity setpoint when the outdoor temperature changes. Use higher humidity setpoints when the temperature is warmer, and lower setpoints when the temperature is cooler.

# What do the lights tell me?

The HM700 user interface includes 2 LEDs that provide information about the humidifier status.

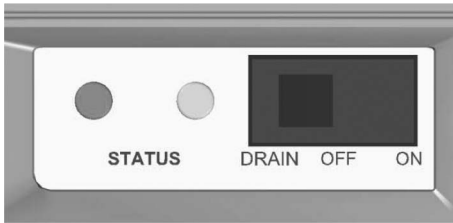

## **Yellow and Green LED Flashing.**

Indicates there is no request for humidity.

## **Yellow LED Flashing.**

Fault detected, humidifier has stopped operating.

## **Green LED Flashing.**

Indicates the humidifier is powered, but the control equipment (stat, air proving, fan, etc.) has interrupted the call for humidity.

## **Yellow LED On.**

Indicates that water level is high. When the yellow LED is steady on (not flashing) it indicates that the high water sensor has interrupted filling of the cylinder. The LED is on for information only and unless it persists for an extended period of time, it does not require any action.

## **Green LED On.**

Indicates steam is being produced.

## What should I do at the end of the season?

The Electrode Steam automatically shuts down when humidity is not needed for an extended period. After several days of inactivity, the water tank will drain and remain empty until humidity is called again. This prevents water from stagnating inside the tank. The Electrode Steam will refill the tank with water and reset itself when your control calls for humidity again.

- **What if I go on vacation?** Even though the Electrode Steam's water tank will drain automatically after several days, Honeywell recommends shutting off the Electrode Steam water supply and turning off the humidity control for extended leaves. Upon return, turn on the water supply and reset the control to the desired setpoint.

## What should I do if the LED light is blinking, or if something is wrong?

The lights will blink when the internal diagnostics systems needs attention. See LED list on page 11.

- Call customer care or your HVAC professional for all service requirements

# 5-Year Limited Warranty

Honeywell warrants this product to be free from defects in the workmanship or materials, under normal use and service, for a period of five (5) years from the date of purchase by the consumer. If at any time during the warranty period the product is determined to be defective or malfunctions, Honeywell shall repair or replace it (at Honeywell's option).

If the product is defective,

- (i) return it, with a bill of sale or other dated proof of purchase, to the place from which you purchased it; or
- (ii) call Honeywell Customer Care at 1-800-468-1502. Customer Care will make the determination whether the product should be returned to the following address: Honeywell Return Goods, Dock 4 MN10-3860, 1885 Douglas Dr. N., Golden Valley, MN 55422, or whether a replacement product can be sent to you.

This warranty does not cover removal or reinstallation costs. This warranty shall not apply if it is shown by Honeywell that the defect or malfunction was caused by damage which occurred while the product was in the possession of a consumer.

Honeywell's sole responsibility shall be to repair or replace the product within the terms stated above. HONEYWELL SHALL NOT BE LIABLE FOR ANY LOSS OR DAMAGE OF ANY KIND, INCLUDING ANY INCIDENTAL OR CONSEQUENTIAL DAMAGES RESULTING, DIRECTLY OR INDIRECTLY, FROM ANY BREACH OF ANY WARRANTY, EXPRESS OR IMPLIED, OR ANY OTHER FAILURE OF THIS PRODUCT. Some states do not allow the exclusion or limitation of incidental or consequential damages, so this limitation may not apply to you.

THIS WARRANTY IS THE ONLY EXPRESS WARRANTY HONEYWELL MAKES ON THIS PRODUCT. THE DURATION OF ANY IMPLIED WARRANTIES, INCLUDING THE WARRANTIES OF MERCHANTABILITY AND FITNESS FOR A PARTICULAR PURPOSE, IS HEREBY LIMITED TO THE FIVE-YEAR DURATION OF THIS WARRANTY. Some states do not allow limitations on how long an implied warranty lasts, so the above limitation may not apply to you.

This warranty gives you specific legal rights, and you may have other rights which vary from state to state.

If you have any questions concerning this warranty, please write Honeywell Customer Relations, 1985 Douglas Dr. Golden Valley, MN 55422 or call 1-800-468-1502.

WARRANTY

**Automation and Control Solutions**

Honeywell International Inc.  
1985 Douglas Drive North  
Golden Valley, MN 55422

<http://yourhome.honeywell.com>

**Honeywell**

® U.S. Registered Trademark.  
© 2015 Honeywell International Inc.  
33-00165—01 M.S. 11-15  
Printed in U.S.A.